

**Movimentazione monodirezionale
con antifalsamanovra**

*Mono-directional movement mechanism
with anti-false manoeuvre*

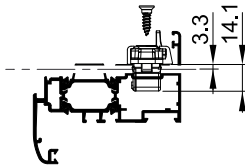
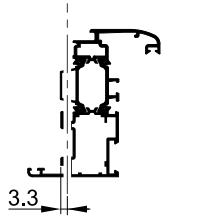
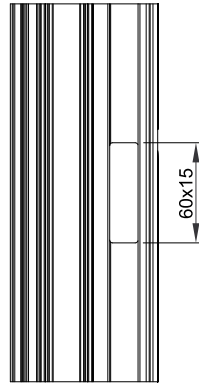
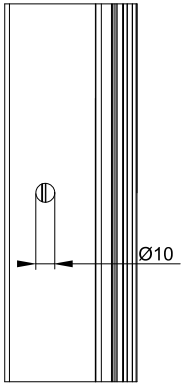

**Compatibile con martelline serie
3090 - 3091 - 3092 - 3093**

Suitable with handles:
3090 - 3091 - 3092 - 3093

Fasi di montaggio

Mounting steps

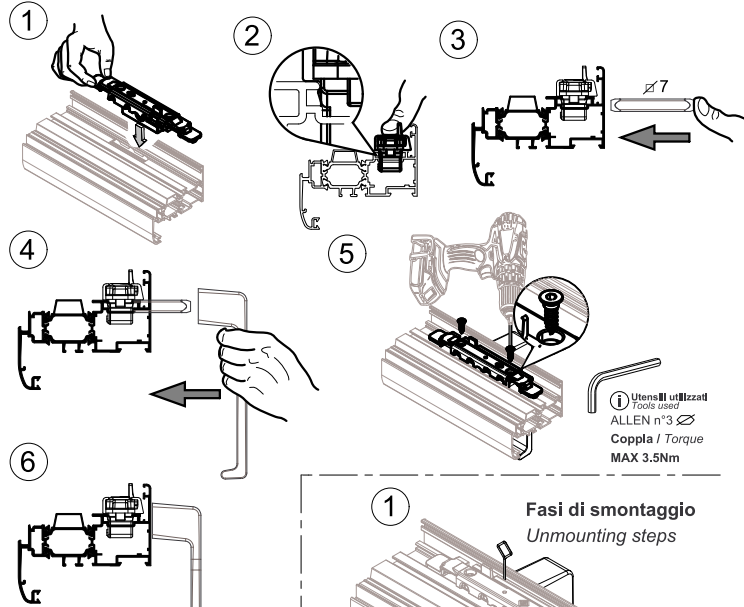

Utensili utilizzati
Tools used
ALLEN n°3
Coppla / Torque
MAX 3.5Nm

Fasi di smontaggio

Unmounting steps

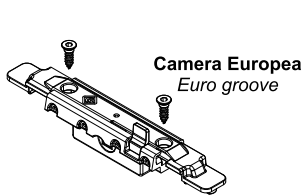
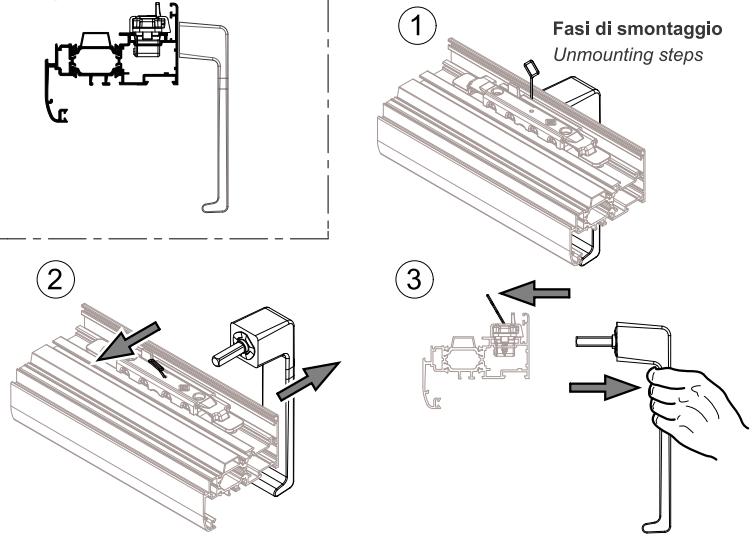

**Camera Europea
Euro groove**

Riferimento nodo Camera Europea
Euro groove section referimnt

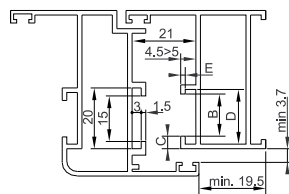

B	C	D	E
14	4	18	1,5
13,5	3,2	16,8	2,4
12	2,9	15	1,5
10	4,2	14,5	1,5



3630
**Movimentazione monodirezionale
con antifalsamanovra**
*Mono-directional movement mechanism
with anti-false manoeuvre*

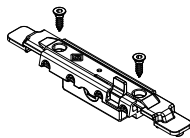

3630.10
**Movimentazione monodirezionale
senza antifalsamanovra**
*Mono-directional movement mechanism
without anti-false manoeuvre*

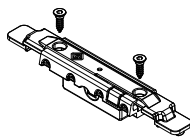

Punto di chiusura supplementare (opzionali)
Additional locking point (optional)

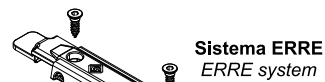

**Sistema ERRE
ERRE system**

Riferimento nodo sistema ERRE
ERRE system section referimnt

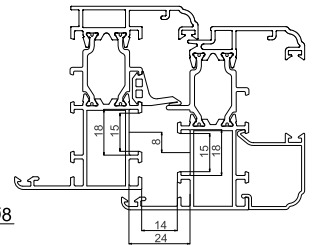

3631
**Movimentazione monodirezionale
con antifalsamanovra**
*Mono-directional movement mechanism
with anti-false manoeuvre*

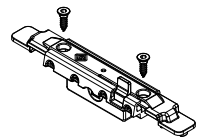

3631.10
**Movimentazione monodirezionale
senza antifalsamanovra**
*Mono-directional movement mechanism
without anti-false manoeuvre*

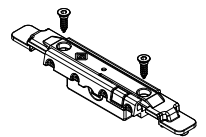

Punto di chiusura supplementare (opzionali)
Additional locking point (optional)



**Schema taglio astine generale anta ribalta
con movimentazione monodirezionale Shark**

*General instruction of machining for Tilt and
Turn with unidirectional movement Shark*

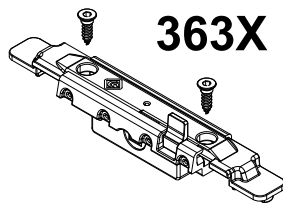

363X

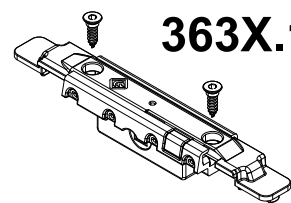

363X.10

Camera Europea | Euro groove **3630 - 3630.10**

Camera Erre | Erre groove **3631 - 3631.10**

Art.3420F/G/N.1



con **3400F/G/N.32**
with

Z-249

3630

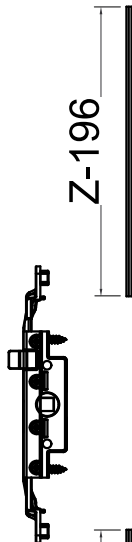

Z-196

Y-166

Ween

Camera Europea | Euro groove

Art.3450F/G/N.1

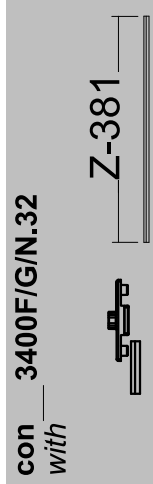

con **3400F/G/N.32**
with

Z-381

3630.10

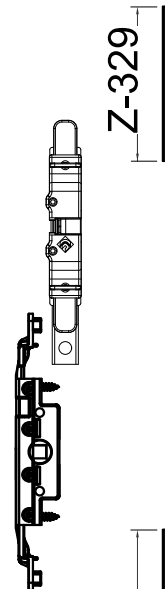

Z-329

Y-166

Ween

Camera Europea | Euro groove

Art.3421G.1

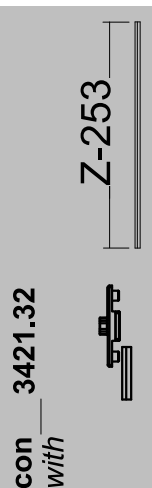

con **3421.32**
with

Z-253

3631

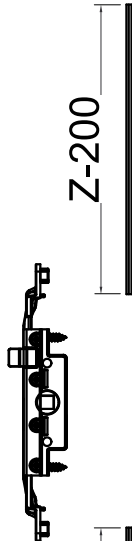

Z-200

Y-225

Ween

Camera Erre | Erre groove

Art.3451G.1

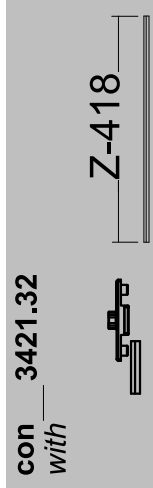

con **3421.32**
with

Z-418

3631.10

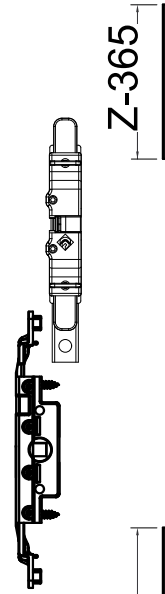

Z-365

Y-225

Ween

Camera Erre | Erre groove