



MASTER

ACCESSORI PER SERRAMENTI PROGETTATI PER DURARE
SCHEMA TECNICA DI MONTAGGIO



Martelline Minimali Int.43mm

<http://www.masteritaly.com>

MANIGLIE CON PERNO REGOLABILE E DESIGN INTERCAMBIABILE

A309x.x

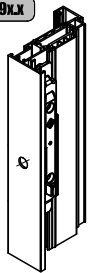

A3090.x

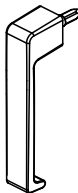

A3091.x



A3092.x

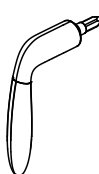

A3093.x



A309x.2x

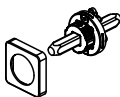
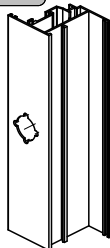

A3090.2x

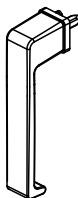

A3091.2x

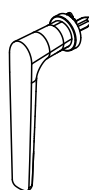

A3092.2x



A3093.2x



A309x.3x

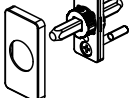
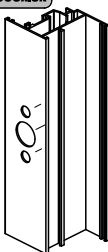

A3090.3x

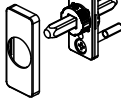
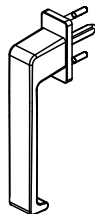

A3091.3x

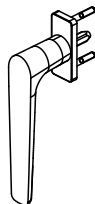

A3092.3x

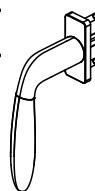

A3093.3x

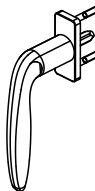

A305x.MX

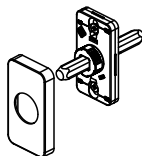

A3050

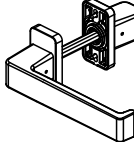

A3051

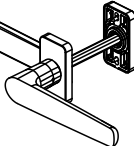

A3052

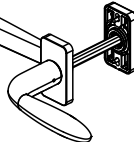

A3053

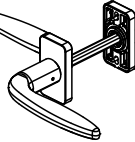

A3050.10

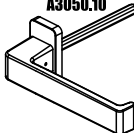

A3051.10



A3052.10

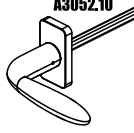

A3053.10



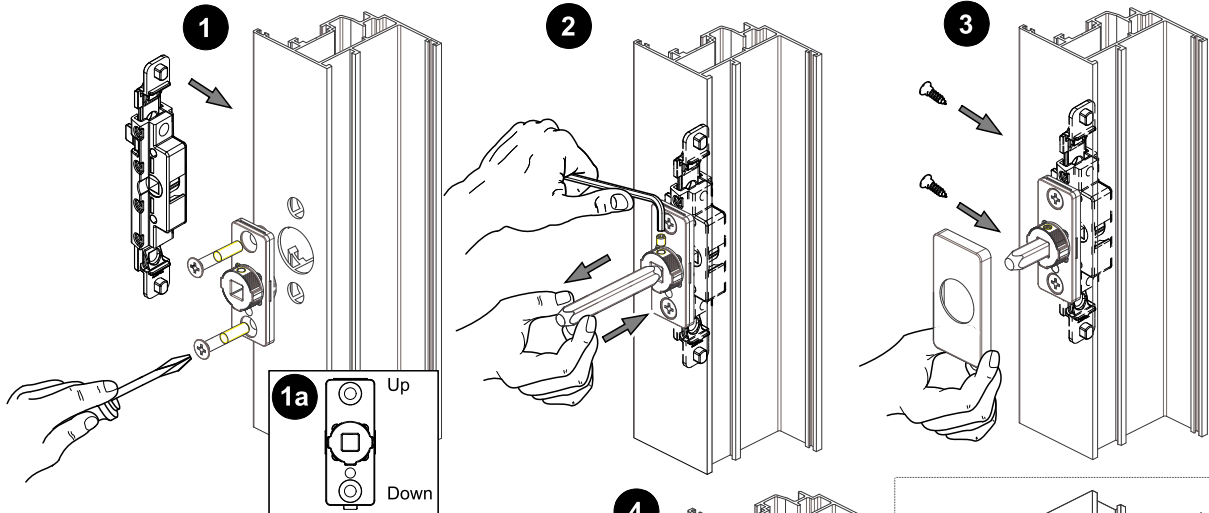
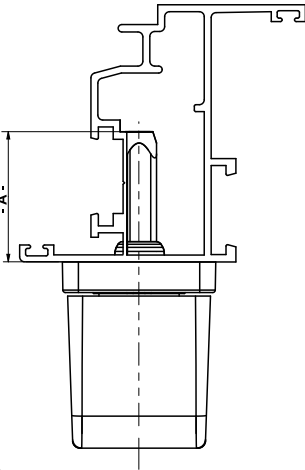
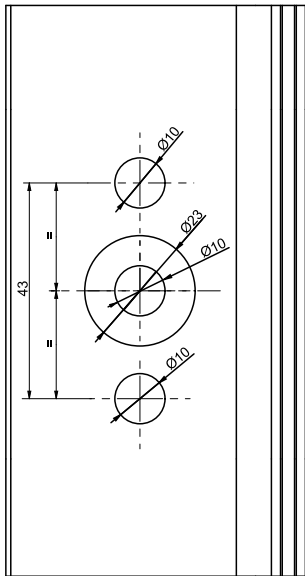

| DESCRIZIONE | ARTICOLO | - A - |
|--|----------|-------------|
| Martellina Minimale Int 43mm linea Italia | 3090.30 | 17,5 - 27mm |
| | 3090.31 | 27,5 - 37mm |
| | 3090.32 | 32,5 - 42mm |
| | 3090.33 | 42,5 - 52mm |
| | 3090.34 | 62,5 - 72mm |
| Martellina Minimale Int 43mm | 3091.30 | 8,5 - 27mm |
| | 3091.31 | 18,5 - 37mm |
| | 3091.32 | 23,5 - 42mm |
| | 3091.33 | 33,5 - 52mm |
| | 3091.34 | 53,5 - 72mm |
| Martellina Minimale Int 43mm | 3092.30 | 8,5 - 27mm |
| | 3092.31 | 18,5 - 37mm |
| | 3092.32 | 23,5 - 42mm |
| | 3092.33 | 33,5 - 52mm |
| | 3092.34 | 53,5 - 72mm |
| Martellina Minimale Int 43mm | 3093.30 | 8,5 - 27mm |
| | 3093.31 | 18,5 - 37mm |
| | 3093.32 | 23,5 - 42mm |
| | 3093.33 | 33,5 - 52mm |
| | 3093.34 | 53,5 - 72mm |

